

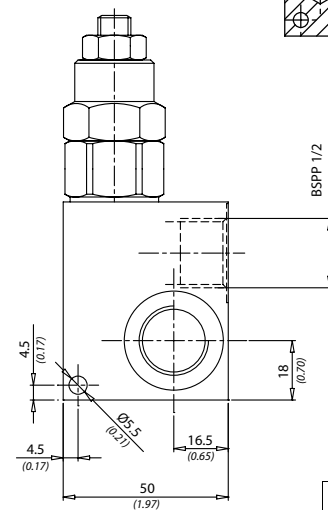

Dati tecnici Technical data	
Viscosità fluido Fluid viscosity	10-500 mm ² /s 45 to 2000 ssu (6 to 420 cSt)
Classe di contaminazione Filtration	ISO code 16/13 SAE class 4 or better
Temperatura fluido Fluid temperature	-20°C +80°C -4°F + 176°F
Temperatura ambiente Ambient temperature	-20°C +50°C -4°F +122°F

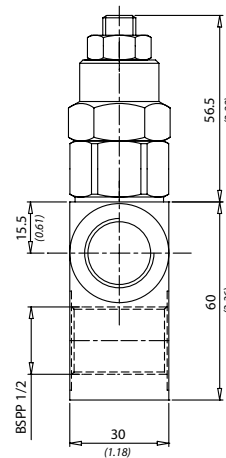

mm
Inches

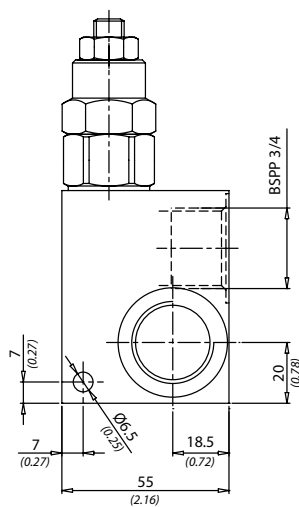
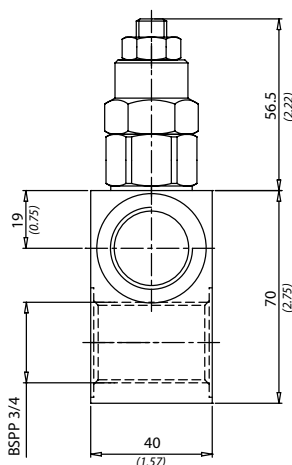
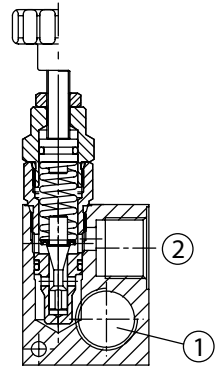
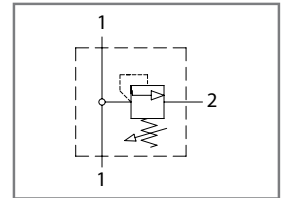
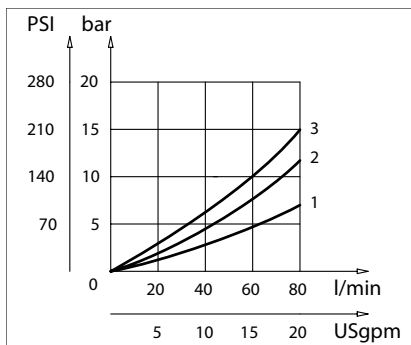
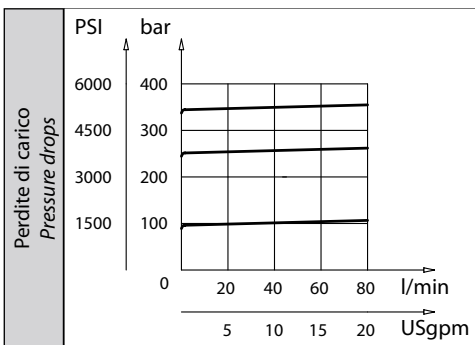

Caratteristiche tecniche Technical performances			
Codice Code	Portata Max Max flow l/min - USgpm	Pressione Max Max pressure bar/PSI	Peso approssimativo Approx weight Kg / lb
VMDR90120	80 (20)	350 (5000)	0,67 (1.5)
VMDR90340			1 (2.2)

Codice ordinazione Ordering code			
VMDR90 - X - Y - K			
X	Dimensione / Size	Y	Regolazione / Setting
120	BSPP 1/2	C	
340	BSPP 3/4		
K	Molla - Spring	V	
1	100 bar (1450 PSI) max		
2	250 bar (3500 PSI) max		
3	350 bar (5000 PSI) max	S	